

IMPLANTABLE
DEVICES

TMB-10

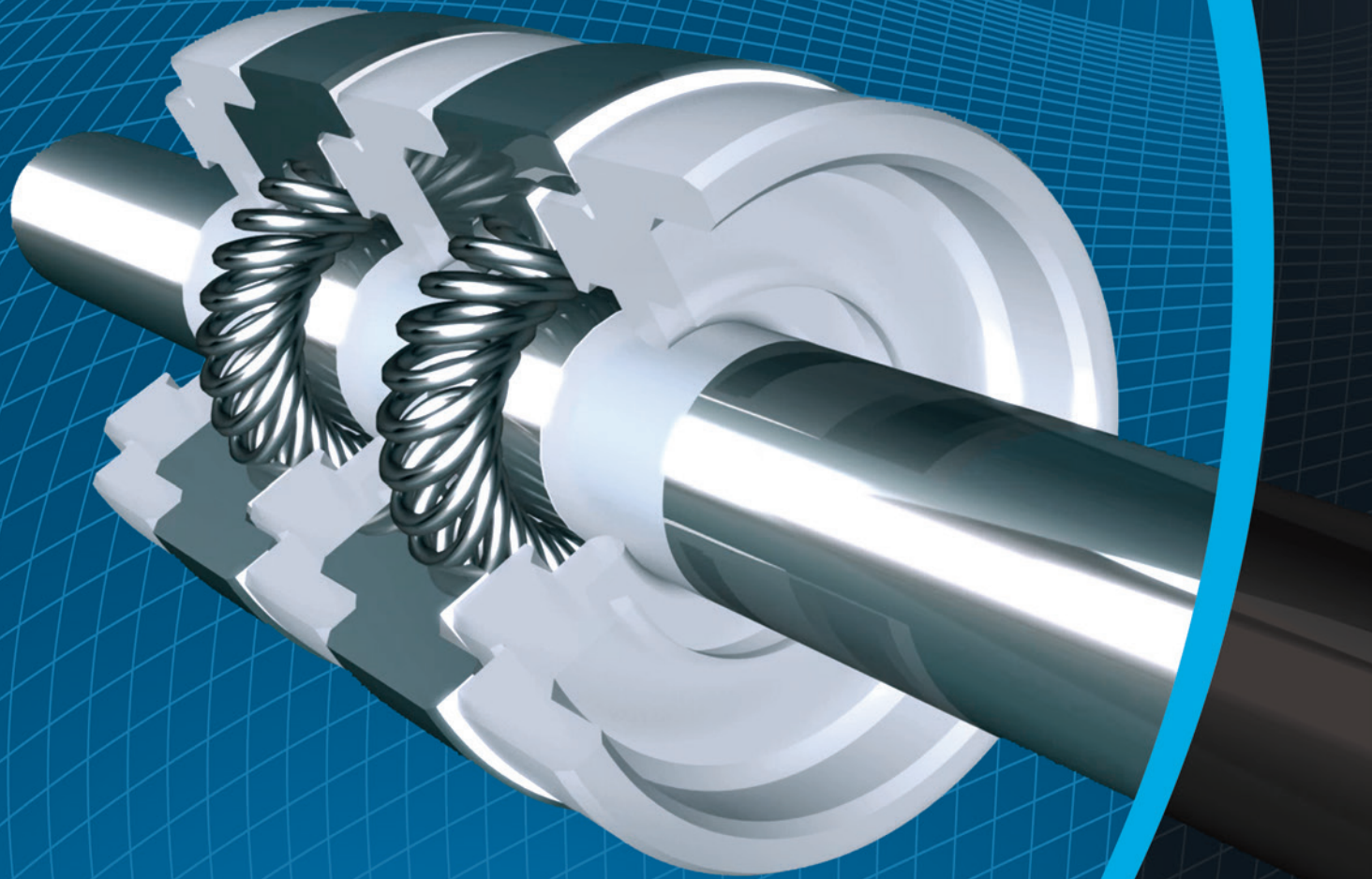

Electrical Contact Solutions for Medical Active Implantables

Custom components that drive tomorrow's technologies.®

BAL SEAL
ENGINEERING, INC.



Helping Device OEMs Connect with Confidence

When manufacturers of active implantables need low-force, low-resistance connecting solutions they can be confident about, they turn to Bal Seal Engineering.

For more than 20 years, our electrical contact technology, based on our proven, robust Bal Spring® canted coil spring, has been making reliable connections in pacemakers, defibrillators, neurostimulators, and many other active implantable devices used to deliver life-improving therapies to the human body.

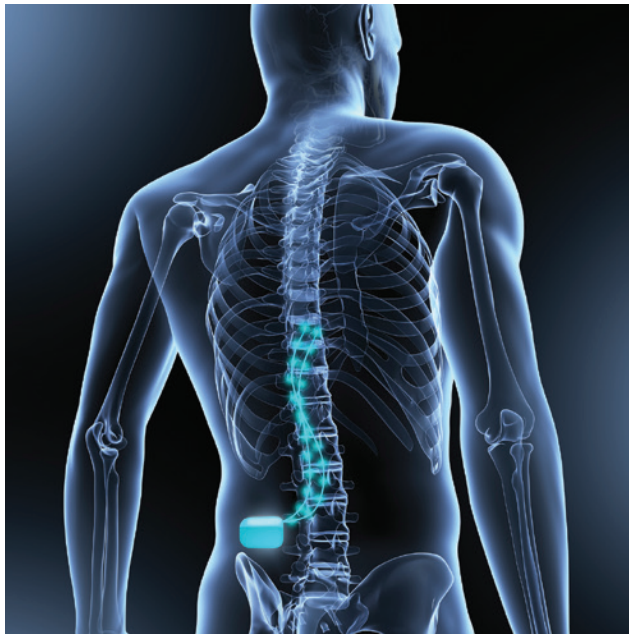

Already at work in more than a million implantables worldwide, our electrical connecting and conducting components are a proven solution for both existing and emerging therapies.

Precision-engineered and manufactured from biocompatible materials, our customizable solutions offer high performance and superior conductivity in a compact footprint that gives OEMs the ability to advance technology and increase device functionality, while enabling surgeons to more simply and safely connect leads to implantable devices. Our two manufacturing locations enable us to mitigate risk and ensure on-time delivery.



Technology at the Core

At Bal Seal Engineering, the solutions we develop are centered on our Bal Spring® canted coil spring technology. In electrical connecting applications, the spring's individual coils provide multi-point contact, and multiple coils provide further redundancy. Their controllable force compensates for irregularities in mating surfaces that might otherwise compromise performance. The Bal Spring can be customized to meet application-specific insertion/extraction force requirements, and their unique design gives them superior resistance to compression set.

Typical Force Deflection Curves

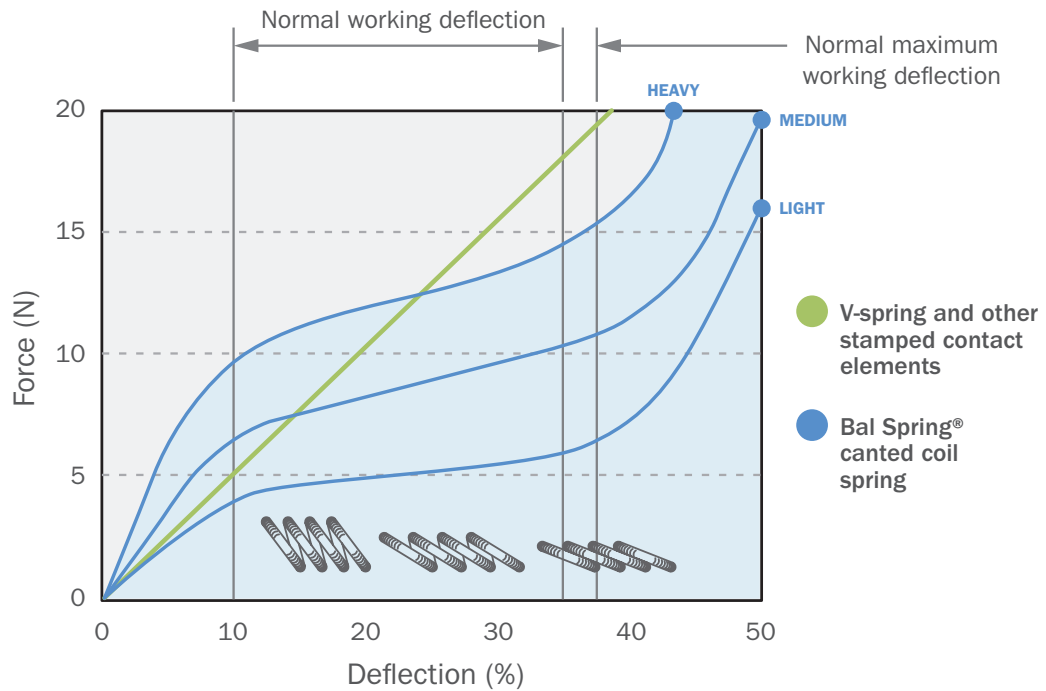



Bal Conn® Electrical Contact



The Bal Conn® is an electrical contact component that remains the stand-alone solution of choice for OEMs seeking to ensure consistent, reliable connections in implantable devices used to deliver neuromodulation and cardiac therapies. For over two decades, the Bal Conn has been helping manufacturers improve device performance and push the technology envelope. It has also dramatically simplified the process surgeons use to connect leads to implantables across the therapy spectrum, shortening procedure times. Due to its redundant contact points, the Bal Conn offers low contact resistance. Its canted coils provide excellent resistance to fatigue and more design flexibility than any other implantable device interconnect technology. With its ability to offer low insertion force and uncompromising electrical conductivity, the Bal Conn is ideal for use in devices with high connection counts.

Bal Conn® Technical Specifications

Application	Lead Diameter (mm)	Force Category	Breakout Force (N)	Running Force Range (N)		Housing Material	Spring Material	Static Dry Contact Resistance (mΩ)	
			Max	From	To			Nominal	Tolerance
Neuro (Bi-directional)	1.35	Medium	1.20	0.09	0.40	MP35N®	Platinum Iridium	70	±20
						316L	Platinum Iridium	600	±200
		Light	0.70	0.07	0.30	Medical-Grade Titanium	Platinum Iridium	350	±150
						MP35N®	Platinum Iridium	80	±30
						Platinum Iridium	Platinum Iridium	40	±15
IS-1 (Bi-directional)	2.67	Medium	3.10	0.50	0.90	316L	MP35N®	100	±60
IS-4/DF-4 (Uni-directional)	3.20	Heavy	2.70	0.50	1.00	MP35N®	MP35N®	80	±50
IS-4/DF-4 (Bi-directional)	3.20	Medium	2.70	0.25	0.75	MP35N®	Platinum Iridium	40	±20
VAD	3.20	Medium	2.70	0.25	0.75	Platinum Iridium	Platinum Iridium	30	±20

This data is presented for comparative purposes only, and it represents the performance of the Bal Conn electrical contact under specific design parameters. Customer results may vary depending upon application requirements and other factors.

Bal Conn® Applications

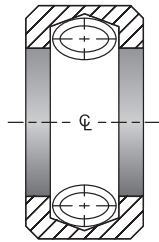
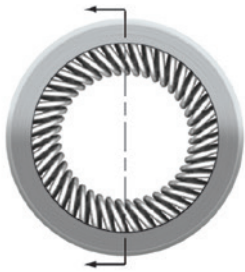

For Neuromodulation Applications

Bi-directional

KEY POINTS

1. Creates consistent force during insertion and removal by limiting spring movement
2. Reduces contact resistance due to more points of contact
3. Supports minimized insertion forces without compromising performance
4. Compact size allows for increased connections in series

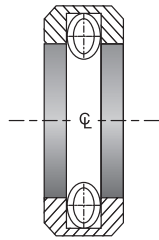
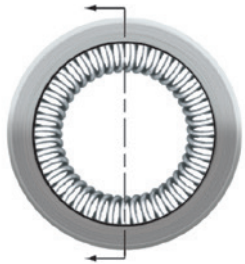

For IS-1 Cardiac Applications

Bi-directional

KEY POINTS

1. Proven to work with IS-1 seal elements
2. Axial spring design enables low contact resistance without noble metals
3. Potential replacement for set screw to reduce duration of surgery and eliminate leak path

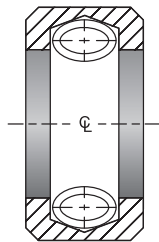
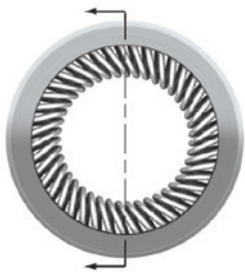

For IS-4/DF-4/VAD Cardiac Applications

Bi-directional

KEY POINTS

1. Creates consistent force during Insertion and removal by limiting spring movement
2. Reduces contact resistance due to more points of contact
3. Supports minimized insertion forces without compromising performance
4. Meets ISO 27186 requirements for force and contact resistance
5. Noble metals required to achieve optimal contact performance

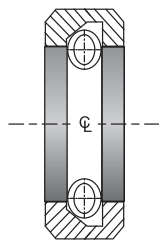

Uni-directional

KEY POINTS

1. Consistent uni-directional Insertion and removal force
2. Axial spring design enables low contact resistance
3. Meets ISO 27186 requirements for force and contact resistance
4. Achieves optimal contact performance without use of noble metals



The SYGNUS® Implantable Contact System

The SYGNUS® Implantable Contact System

SYGNUS® is the world's first integrated seal and electrical contact system for active implantable devices. It is engineered to help device OEMs accelerate time to market and dedicate valuable resources to therapy and function improvements, instead of component development and testing.

This innovative system combines reliable Bal Conn® electrical contact technology with proven implantable-grade silicone isolation seals, resulting in a densely spaced connector "stack" that can accommodate leads with diameters down to 0.7 mm. The system's contact element consists of a housing made from medical-grade MP35N® and a platinum-iridium or MP35N® Bal Spring® canted coil spring. The spring contact offers low insertion force, provides multi-point conductivity, and compensates for both misalignment and mating surface irregularities.

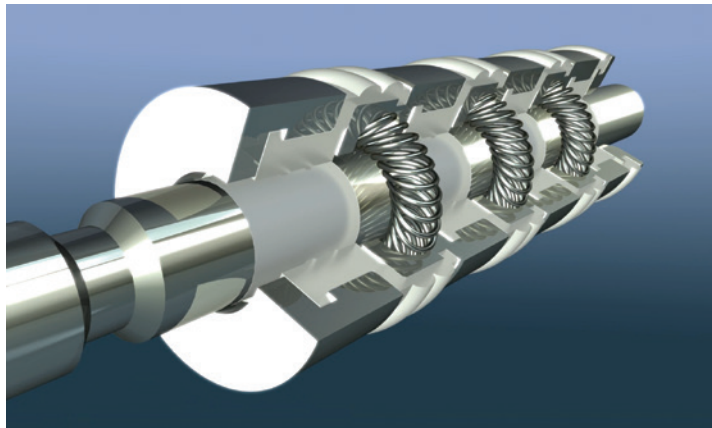

SYGNUS precision-engineered silicone seals provide superior dielectric isolation for the prevention of signal leakage that can result in potential device malfunction.

SYGNUS is scalable and completely configurable—the number of contacts and seals in the system can be specified to support unique application and industry requirements. Regardless of configuration, the SYGNUS system's contact designs are subjected to comprehensive force testing. Its proven sealing components are packaged to critical clean standards.

The SYGNUS® Difference

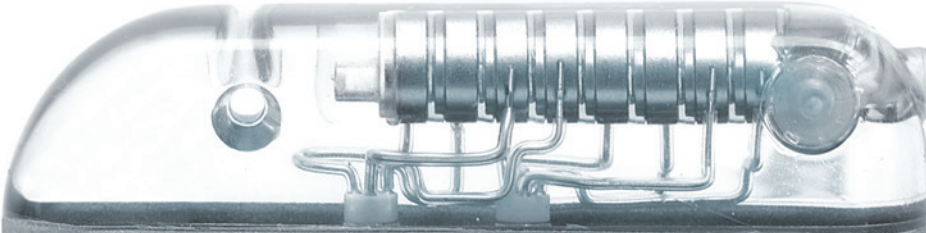

PROVEN

- Incorporates the same proven Bal Conn® electrical contact technology used in more than a million of today's implantable devices
- Spring component's inherent multi-point conductivity reduces risk of failure due to connection loss

COMPACT

- Offers one of the smallest pitches in the industry (~ 2 mm)
- Provides opportunity for greater connector density, resulting in more device functionality

INTEGRATED DESIGN

- Combines electrical contacts with fluid and electrical isolation components
- Eliminates the need for dual sourcing and/or internal component development

CONFIGURABLE

- Provides options for standard sizes in variable stack arrays
- Gives OEMs a basic technology platform for a wide range of size and design options



The SYGNUS[®] Implantable Contact System

SYGNUS[®] for Neuromodulation Applications

For manufacturers of devices used to deliver neuromodulation therapies, package size reduction is a constant challenge. The compact design of our SYGNUS implantable contact system lets OEMs conserve space without compromising performance. By offering one of the industry's smallest pitches and combining both isolation seals and electrical contacts into a dense, configurable stack, SYGNUS allows for a greater number of contacts to be used. The result is a decrease in overall device volume and an increase in functionality.

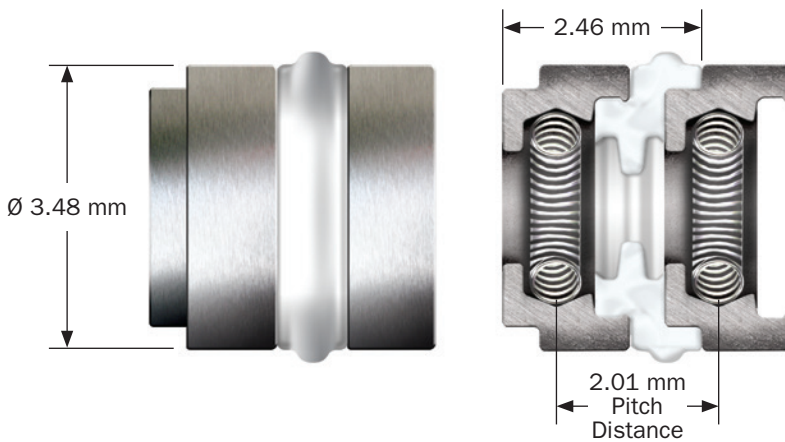
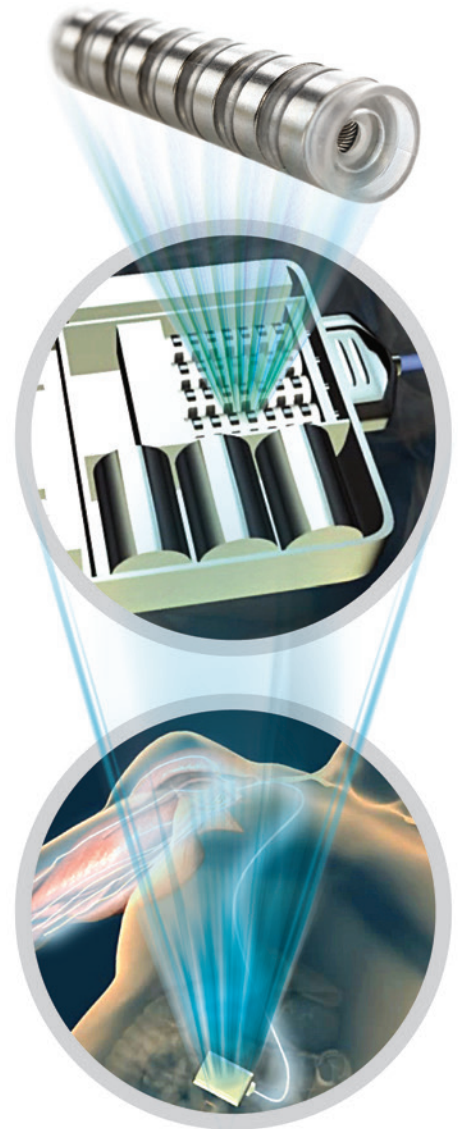

Model	Functional Attributes					Physical Attributes			
	Lead Diameter (mm)	Insertion Force (N)	Extraction Force (N)	Electrical Isolation (kΩ)	Dry Static Contact Resistance (mΩ)	Housing	Materials	Seal	Pitch Distance (mm)
Neuro (Unit)	1.30	<0.8	<1.4	>250	<100	MP35N [®]	Platinum Iridium	Implantable Silicone	2.01

This data is presented for comparative purposes only, and it represents the performance of the SYGNUS[®] implantable contact system under specific design parameters. Customer results may vary depending upon application requirements and other factors.

SYGNUS® for Cardiac Health Management Applications

While reliability is always a primary concern for manufacturers of implantable devices used in cardiac healthcare management therapies, integration and ease of use have become equally important factors in choosing components that form the critical lead/connector interface. The SYGNUS implantable contact system offers OEMs a more efficient, plug-and-play option for integrating proven sealing and connecting technology into a standard platform.

SYGNUS® for Emerging Therapies

The SYGNUS implantable contact system's integrated design and proven performance, coupled with its ability to stack a greater number of contacts in a smaller space, makes it ideal for use in the development of breakthrough implantable device technologies. OEMs seeking ways to systemize and miniaturize have already begun to leverage the unique physical and functional attributes of the SYGNUS system to improve the capability of devices used in therapies such as VAD, deep brain, cochlear, vagus nerve, spinal stimulation, and others. Soon, the system will be playing a similar role in connecting patients through even smaller lead interfaces to cutting-edge treatments for hearing loss and vision impairment.

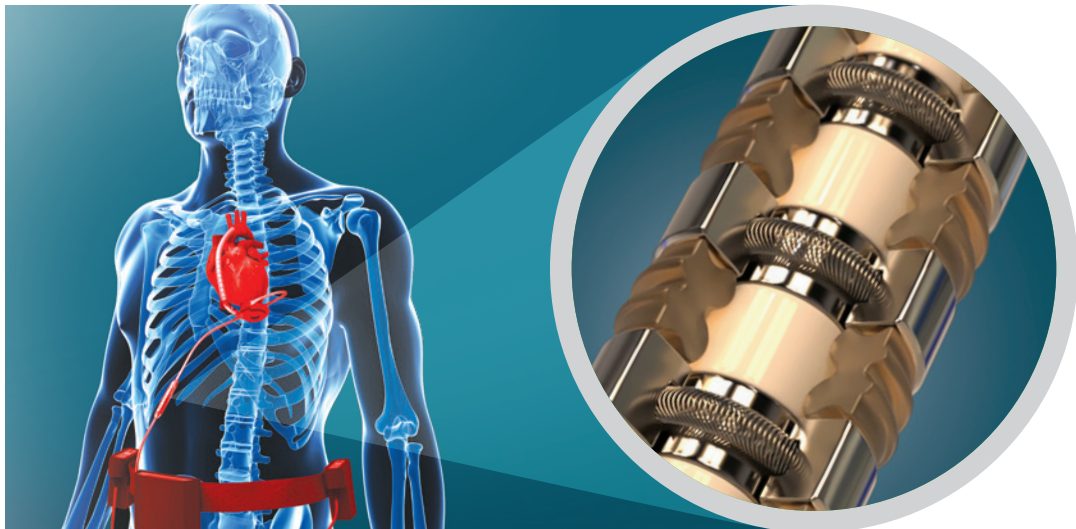

The SYGNUS® implantable contact system facilitates ultra-reliable inline connection of the VAD pump to power source, providing device makers with a proven contact/seal solution, and allowing replacement of lead segment with lower patient risk.



Pushing the Technology Envelope

We share your passion for developing technologies that help shape industry standards and dramatically improve quality of life. That's why our research and development team creates and evaluates new electrical contact options designed to meet your unique requirements for performance, size, and efficiency.

Next-generation Bal Conn® Electrical Contacts

Engineered to offer performance characteristics comparable to those of our standard Bal Conn® product in an alternative form factor, the next-generation Bal Conn represents a new option for device manufacturers seeking to integrate high-quality, ultra-reliable components that carry current from battery to lead in medical active implantables. The next-generation Bal Conn supports reduced axial pitch, and exhibits lower electrical impedance. It employs our proven Bal Spring® canted coil spring technology, and its construction supports high-volume production. Several groove configurations are available to accommodate a range of design and performance requirements.

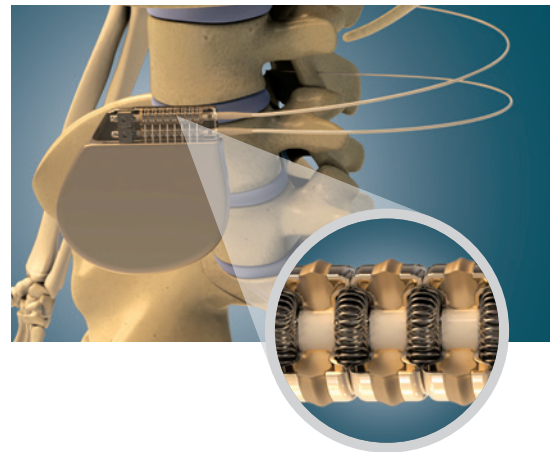

Bal Conn® High Density Vertical Array

In order to help engineers dramatically improve device functionality while reducing overall package size, we've also developed a high density vertical array design that can be incorporated into new and emerging therapy platforms. The design is based on the creation of a subassembly consisting of one or more small Bal Conn electrical contacts, a non-conductive polymer interface, and an implantable-grade silicone seal. The subassembly, which can incorporate a cap or cover design, uses vertically positioned pins or rods of varying diameters to double or triple the amount of connections available to the device lead. It is engineered to minimize insertion force issues that can present challenges in serial arrays with small leads, and it offers designers new opportunities for improved contact density.

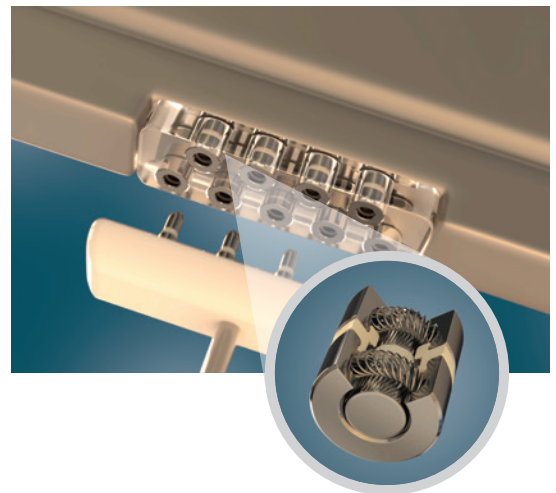

Important Information

It is essential the end user run evaluation testing under actual service conditions with a sufficient safety factor to determine if the proposed, supplied, or purchased Bal Seal Engineering products are suitable for the intended purpose. Welded springs have an increased probability of breaking or failing at or adjacent to the weld as opposed to other areas of the spring. This probability is increased further if the spring is used in an application involving extension of the spring. Temperature affects the properties (i.e. tensile strength, elongation, etc.) of the spring. Failure of Bal Seal Engineering, Inc. products can cause greater leakage, equipment failure, property damage, personal injury, and/or death. Equipment containing Bal Seal Engineering products must be designed to provide for the safe handling of any eventuality that may result from a partial or total failure of said Bal Seal Engineering products. Bal Seal Engineering products must be tested with a sufficient safety factor after installation. A program of regular maintenance and inspection must be performed. The user, through their own analysis and testing, is solely responsible for making the final selection of the products and for assuring that all performance, safety, and warning requirements of the application are met.

CLEANING

Customer/end user is advised that Bal Seal Engineering products may require cleaning and/or sterilization prior to usage, depending on the application.

IMPORTANT: DISCLAIMER OF ALL WARRANTIES

THE IMPLIED WARRANTIES OF MERCHANTABILITY AND FITNESS FOR A PARTICULAR PURPOSE AND ALL WARRANTIES, IMPLIED OR EXPRESS, ARE EXCLUDED AND SHALL NOT APPLY TO BAL SEAL OR BAL SEAL ENGINEERING PRODUCTS.

All statements, technical information and recommendations herein are based on tests we believe to be reliable. But the accuracy or completeness thereof is not guaranteed. All such statements, technical information, and recommendations shall not be the basis of any bargain with Bal Seal Engineering or any seller and do not constitute a warrant that the goods will conform to any statements, technical information, or recommendations. The use of any such statement, information or recommendation is solely for the purposes of identification or illustration and is not to be construed as a warranty that any goods will conform to such statements, information, or recommendations. No affirmation of fact or promise

made by Bal Seal Engineering or any seller will constitute a warranty that any goods will conform to the affirmation or promise. Before using any product, the user shall determine the suitability of the product for its intended use, and the user assumes all risk and liability whatsoever in connection therewith. No one, including company representatives, wholesalers, distributors, salespersons, or employees of Bal Seal Engineering, is authorized to make any warranty or representation, and no customer or user may rely on any warranty or representation. Bal Seal Engineering reserves the right to make any changes without notice in our products and in the information and contents of this document/brochure. Such information can include, but is not limited to, dimensional data, force, torque, materials, pressures, temperatures, surface finishes, etc.

Nothing contained herein or in any of our literature shall be considered a license or recommendation to use any process or to manufacture or to use any product in conflict with existing or future patents, covering any product or material or its use.

The buyer shall hold and save the company, its officers, agents, and employees, harmless from liability of any nature or kind for or on account of the use, sale or lease of any patented or unpatented invention, article, or appliance, furnished or used hereunder.

LIMITATION OF LIABILITY/REMEDIES

It is agreed that the liability of the seller and Bal Seal Engineering, whether as a result of breach of any warranty, if any warranty in fact be found to exist, negligence, other tort, breach of contract or otherwise shall be limited to replacing the non-conforming Bal Seal Engineering product or any part thereof, or, at seller's option, to the repayment to the buyer of the purchase price paid by buyer in respect of which damages are claimed upon return to the seller, freight prepaid, of the non-conforming product or part thereof. Seller shall not be liable in tort or in contract for any other damages, direct, indirect or consequential. Any claims must be made in writing and within 28 days of shipment of goods to receive consideration.

Copyright ©2018, Bal Seal Engineering, Inc.

*Products described herein may be protected by one or more of the following U.S. patents: 9,011,169; 8,167,660, and others as well as foreign patents or products where patents are pending.
(LE-88G) (170-3-1)

We're more than just a component maker. In early development or existing product improvement stages, we combine our proven seals, springs, and contacts with engineering, material science, and precision manufacturing expertise to produce solutions that break down performance barriers.



Americas

Bal Seal Engineering, Inc.
19650 Pauling, Foothill Ranch, CA 92610-2610
Telephone +1 949 460 2100 or Toll Free +1 800 366 1006



Europe, Middle East, Africa

Bal Seal Engineering Europe B.V.
Jollemanhof 16, 5th floor, 1019 GW Amsterdam
The Netherlands
Telephone +31 20 638 6523

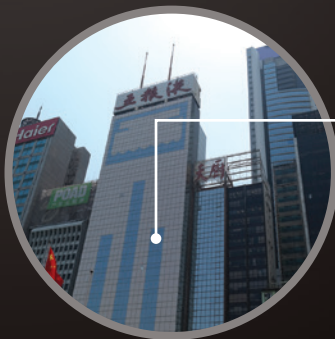

Asia Pacific

Bal Seal Asia Limited
Suite 901, Chinachem Century Tower
178 Gloucester Road, Wanchai, Hong Kong
Telephone +852 28681860



www.balseal.com sales@balseal.com

Custom components that drive tomorrow's technologies.®